

Article number: 203250M1247A1X

Description: E+G levelling foot

GN 32-50-M12-47-A1-X

Note: X With female thread, External hexagon

## Measures

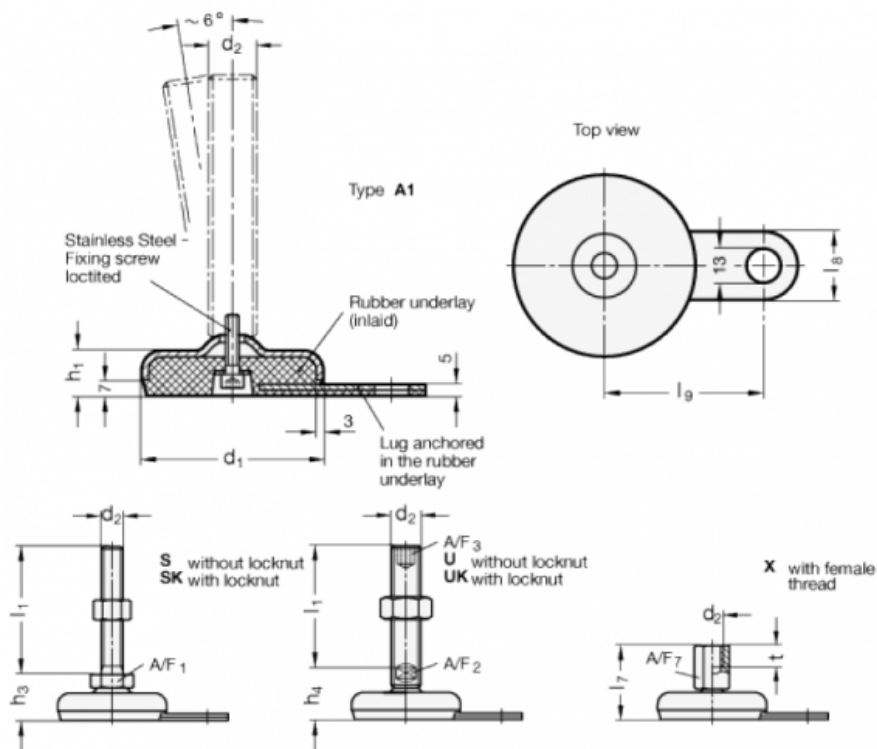

A/F7	= 17
d1	= 50
d2	= M12
h1	= 18
l7	= 47
l8	= 25
l9	= 45
t	= 12